

NOTE. ROD-EYE ORIENTATION NOT GUARANTEED

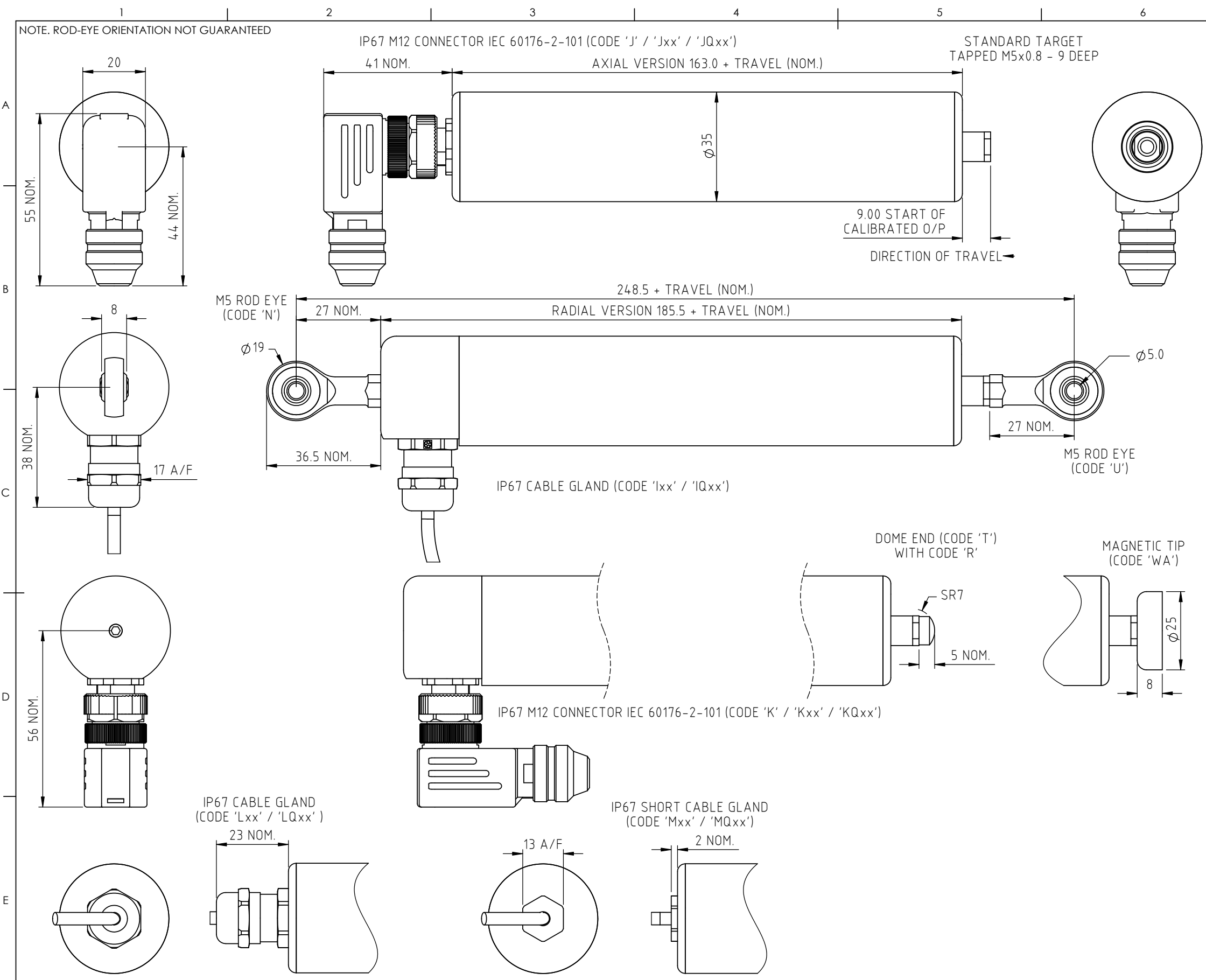

ELECTRICAL OPTIONS/ SPECIFICATIONS  
 OUTPUT 'A' 0.5 - 4.5V RATIOMETRIC SUPPLY CURRENT 12mA TYP. 20mA MAX.  
 SUPPLY (NOM) 5V

CONNECTIONS:	CABLE	CONNECTOR
+Ve	3-CORE RED	RED :1
+SENSE (5-WIRE ONLY)	-	ORANGE :1
0V	BLACK	BLACK :3
-SENSE (5-WIRE ONLY)	-	GRAY :3
OUTPUT	WHITE	BLUE :2
BODY	SCREEN	SCREEN :4

CABLE: 0.2mm<sup>2</sup>, O/A SCREEN, PUR JACKET, SUPPLIED WITH 50cm OR REQUIRED LENGTH IN cm (15000cm MAX).  
 STANDARD 3-CORE: BLACK Ø4mm JACKET e.g. L50  
 OPTIONAL 5-CORE: BLUE Ø4.6mm JACKET e.g. LQ50  
 CONNECTORS: MAXIMUM CONDUCTOR CROSS SECTION 0.75mm<sup>2</sup>

RANGE OF DISPLACEMENT FROM 0-5mm TO 0-800mm e.g. 76.  
 BODY MATERIAL:- STAINLESS STEEL.

FURTHER OPTIONS:  
 BODY CLAMP CODE 'P'  
 TWO BODY CLAMPS CODE 'P2'  
 CLAMP CONSISTS OF 2 PARTS AND REQUIRES 2 M6x55 (MIN.) CAP HEAD SCREWS.

SPRUNG PUSH-ROD, ≤300mm:  
 EXTENDED POSITION CODE 'R'. RETRACTED POSITION CODE 'S'  
 PUSH-ROD FREE CODE 'V' - NOT AVAILABLE WITH CODES 'R' OR 'S'

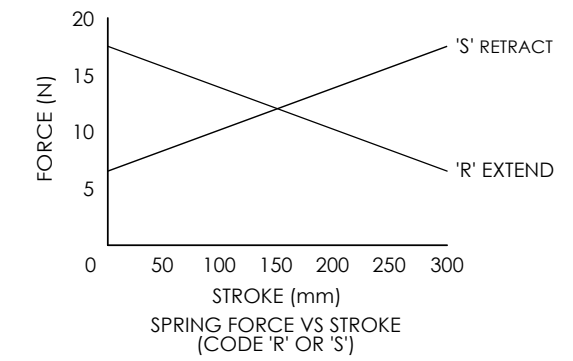

NOTE:- READ INSTALLATION SHEET H000-19 FOR FULL INSTRUCTIONS FOR USE.

**CSA APPROVED TO**  
**Class I Zone 0**  
**Ex/AEx ia IIC T4 (Ta= -40 to 80°C)**  
**AEx ia D IIC T93°C (Ta= -40 to 80°C)**  
**Ui 11.4V, Ii 0.2A, Pi 0.51W**

APPROVED FOR USE IN CONJUNCTION WITH A GALVANICALLY ISOLATED BARRIER.

NOTE: APPROVAL ONLY APPLIES AT NORMAL ATMOSPHERIC PRESSURE!

DRAWINGS NOT TO BE CHANGED WITHOUT REFERENCE TO THE CHANGE PROCEDURE.  
 CHANGES TO PARTS USED IN INTRINSICALLY SAFE PRODUCT MUST BE APPROVED BY THE AUTHORISED PERSON.  
 THIS IS AN UNCONTROLLED PRINT AND WILL NOT BE UPDATED.

REV	CHANGE HISTORY	DR'WN	DATE	CHK'D
G	RAN1311MAG TIP & RAN1425 AMEND MARKINGS	ASC	01/06/2023	ASC

THE PUSH-ROD RETRACTS 4mm NOM. BACK FROM THE START OF CALIBRATED TRAVEL. THE PUSH-ROD EXTENDS 8mm\* NOM. BEYOND THE END OF CALIBRATED TRAVEL. \*SPRUNG OPTIONS:- CODE 'R': 1mm, CODE 'S': 2mm. CODE 'V': PUSH-ROD NOT RETAINED.



APPROVED BY RDM	REV G		X ±0.4 X.X ±0.2 X.XX ±0.1 DIMS mm
DESCRIPTION H101 INTRINSICALLY SAFE STAND ALONE LINEAR POSITION SENSOR			
SCALE A3	1:1.3	DRAWING NUMBER H101-11	
SHEET 1 OF 1			



# H101 STAND-ALONE LINEAR POSITION SENSOR

## INTRINSICALLY SAFE FOR HAZARDOUS DUST ATMOSPHERES

- **Intrinsically safe for Gas and Dust to:**  
**Class I, Zone 0**      **Ex ia / AEx ia**  
**Zone 20**              **Ex ia / AEx ia**  
**Class I, Division 1; Class II, Division 1;**  
**Class III, Division 1**
- **Non-contacting inductive technology to eliminate wear**
- **Travel set to customer's requirement**
- **High durability and reliability**
- **High accuracy and stability**
- **Sealing to IP67**

As a leading designer and manufacturer of linear, rotary, tilt and intrinsically safe position sensors, Positek® has the expertise to supply a sensor to suit a wide variety of applications.

Our intrinsically safe H101 incorporates electronics system EX08 which is CSA approved for use in potentially explosive **gas/vapour and dust** atmospheres. The H101 is designed for industrial and scientific feedback applications and is ideal for OEMs seeking good sensor performance for arduous applications in hazardous areas. The unit is highly compact and space-efficient, being responsive along almost its entire length. The H101, like all Positek® sensors, provides a linear output proportional to travel. Each unit is supplied with the output calibrated to the travel required by the customer, any stroke from 0-5mm to 0-800mm and with full EMC protection built in. The sensor is very robust, the body and push rod being made of stainless steel for long service life and environmental resistance. Overall performance, repeatability and stability are outstanding over a wide temperature range. The sensor is easy to install with mounting options including M5 rod eye bearings and body clamps. The push rod can be supplied free or captive with female M5 thread, an M5 rod eye, dome end or magnetic tip. Captive push rods can be sprung loaded, in either direction, on sensors up to 300mm of travel. The H101 also offers a range of mechanical options, environmental sealing is to IP65 or IP67, depending on selected cable or connector options.



### SPECIFICATION

<b>Dimensions</b>	
Body diameter	35 mm
Body length (Axial version)	calibrated travel + 163 mm
Body length (Radial version)	calibrated travel + 186 mm
Push rod extension	calibrated travel + 9 mm, OD 9.5 mm
<i>For full mechanical details see drawing H101-11</i>	
<b>Independent Linearity</b>	≤ ± 0.25% FSO @ 20°C - up to 450 mm ≤ ± 0.5% FSO @ 20°C - over 450 mm
<b>Temperature Coefficients</b>	< ± 0.01%/°C Gain & < ± 0.01%FS/°C Offset > 10 kHz (-3dB)
<b>Frequency Response</b>	Infinite
<b>Resolution</b>	< 0.02% FSO
<b>Noise</b>	Class I, Zone 0
<b>Intrinsic Safety</b>	Ex ia IIC T4 Ga AEx ia IIC T4 Ga Class I, Zone 20 Ex ia IIIC T135°C Da AEx ia IIIC T135°C Da Class I, Division 1, Groups A, B, C, D; T4 Class II, Division 1, Groups E, F, G, T135°C Class III Division 1; (Ta = -40°C to +80°C)
Approval only applies to the specified ambient temperature range and atmospheric conditions in the range 0.80 to 1.10 Bar, oxygen ≤ 21%	
<b>Sensor Input Parameters</b>	Ui: 11.4V, Ii: 0.20A, Pi: 0.51W.
<b>(connector option/s)</b>	Ci: 1.16µF, Li: 50µH
<b>(cable option/s)</b>	Ci: 1.36µF, Li: 860µH with 1km max. cable
<b>Environmental Temperature Limits</b>	
Operating	-40°C to +80°C
Storage	-40°C to +125°C
<b>Sealing</b>	IP67
<b>EMC Performance</b>	EN 61000-6-2, EN 61000-6-3
<b>Vibration</b>	IEC 68-2-6: 10 g
<b>Shock</b>	IEC 68-2-29: 40 g
<b>MTBF</b>	350,000 hrs 40°C Gf
<b>Drawing List</b>	
H101-11	Sensor Outline
3D models, step or .igs format, available on request.	



# H101 STAND-ALONE LINEAR POSITION SENSOR INTRINSICALLY SAFE FOR HAZARDOUS DUST ATMOSPHERES

Intrinsically safe equipment is defined as "equipment which is incapable of releasing sufficient electrical or thermal energy under normal or abnormal conditions to cause ignition of a specific hazardous atmosphere mixture in its most easily ignited concentration."

CSA approved to;

Class I, Zone 0      Ex ia IIC T4 Ga      AEx ia IIC T4 Ga  
 Class I, Zone 20    Ex ia IIIC T135°C Da    AEx ia IIIC T135°C Da  
 Class I, Division 1, Groups A, B, C, D; T4  
 Class II, Division 1, Groups E, F, G, T135°C;  
 Class III Division 1;  
 (Ta = -40°C to +80°C)

Designates the sensor as belonging to; Class I, Zone 0 / Class I, Zone 20: can be used in areas with continuous, long or frequent periods of exposure to hazardous gas or dust.

Gas:

Protection class ia IIC, denotes intrinsically safe for Zones 0, 1 & 2 and IIA, IIB and IIC explosive gases.

Temperature class T4: maximum sensor surface temperature under fault conditions 135°C.

Dust:

Protection class ia IIIC, denotes intrinsically safe for Zones 20 & 21 explosive dust.

T135°C: maximum sensor surface temperature under fault conditions 135°C.

Ambient temperature range extended to -40°C to +80°C.

It is imperative Positek® intrinsically safe sensors be used in conjunction with a galvanic barrier to meet the requirements of the product certification. The Positek G005 Galvanic Isolation Amplifier is purpose made for Positek IS sensors making it the perfect choice. Refer to the G005 datasheet for product specification and output configuration options.

For cable lengths exceeding 10 metres a five wire connection is recommended to eliminate errors introduced by cable resistance and associated temperature coefficients.

CSA approved sensors suitable for gas (G series) applications, are also available from Positek.

H101	a	b	c	d	e	f	g	h	j	k
	Displacement	A	Y	Connections	Option	Option	Option	Option	Option	Z000

a Displacement	Value
Factory set to any length from 0-5 mm to 0-800 mm (e.g. 0-254 mm)	<b>254</b>
b Output	Code
Supply $V_{dc}$ (tolerance)	<b>Output</b>
+5V (4.5 - 5.5V)	0.5 - 4.5V (ratiometric with supply)
Supply Current 10mA typical, 12mA max.	<b>A</b>
c Calibration Adjustments	Code
Sealed	<b>Y</b>
d Connections	Code
Cable gland radial IP67 Pg9, metal, 3-core cable	<b>Ixx</b>
Cable gland radial IP67 Pg9, metal, 5-core cable	<b>IQxx</b>
Connector axial IP67 4 pin M12 IEC 61076-2-101, metal	<b>J</b>
Connector axial IP67 4 pin M12 IEC 61076-2-101, metal, pre-wired 3-core cable	<b>Jxx</b>
Connector axial IP67 4 pin M12 IEC 61076-2-101, metal, pre-wired 5-core cable	<b>JQxx</b>
Connector radial IP67 4 pin M12 IEC 61076-2-101, metal	<b>K</b>
Connector radial IP67 4 pin M12 IEC 61076-2-101, metal, pre-wired 3-core cable	<b>Kxx</b>
Connector radial IP67 4 pin M12 IEC 61076-2-101, metal, pre-wired 5-core cable	<b>KQxx</b>
Cable gland axial IP67 Pg9, metal, 3-core cable	<b>Lxx</b>
Cable gland axial IP67 Pg9, metal, 5-core cable	<b>LQxx</b>
Cable gland, short <sup>†</sup> axial IP67, metal, 3-core cable	<b>Mxx</b>

d Connections continued	Code
Cable gland, short <sup>†</sup> axial IP67, metal, 5-core cable	<b>MQxx</b>
Specify required cable length 'xx' in cm. e.g. L2000 specifies axial cable gland with 20 m of cable, 50 cm supplied as standard. <b>Note!</b> maximum length supplied 15000cm. <sup>†</sup> Nb: restricted cable pull strength.	
e Body Fittings	Code
None default	blank
M5 Rod-eye bearing radial version only	<b>N</b>
f Body Clamps	Code
Body Clamps 1 pair	<b>P</b>
Body Clamps 2 pairs	<b>P2</b>
g Sprung Push Rod	Code
Not sprung default	blank
Spring extend	<b>R</b>
Spring retract	<b>S</b>
300 mm maximum displacement and captive push rod only.	
h Push Rod Fittings	Code
Female thread M5x0.8x9 deep default	blank
Dome end with spring extend option 'R'	<b>T</b>
M5 Rod-eye bearing	<b>U</b>
Magnetic tip	<b>WA</b>
j Push Rod	Code
Captive push rod retained default	blank
Non-captive push rod can depart body	<b>V</b>
k Z-code	Code
Calibration to suit G005 required	<b>Z000</b>
Tighter Independent Linearity; $\leq \pm xx\%$ FSO @20°C	<b>Z650</b>
$\leq \pm 0.1\%$ 0 - 10 mm min. to 0 - 450 mm	
$\leq \pm 0.25\%$ 0 - 451 mm to 0 - 600 mm	
$\leq \pm 0.5\%$ 0 - 601 mm to 0- 800 mm max.	
1/4" Rod eyes with options 'N' and/or 'U'	<b>Z827</b>

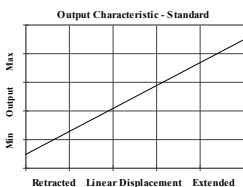

For further information please contact:

[www.positek.com](http://www.positek.com) [sales@positek.com](mailto:sales@positek.com)

Tel: +44(0)1242 820027 fax: +44(0)1242 820615

Positek, Andoversford Industrial Estate, Cheltenham GL54 4LB. U.K.

H101-17h



# Three or Five-Wire Mode Connection

## FOR INTRINSICALLY SAFE SENSORS IN HAZARDOUS ATMOSPHERES

The aim of this document is to help readers who do not understand what is meant by three or five wire modes of connection between the galvanic isolation amplifier and sensor, and the factors behind them. It is by no means an in-depth technical analysis of the subject.

Whether opting for a pre-wired Positek® Intrinsicly Safe sensor or one with a connector, choosing the right mode of connection and cable to suit the application requires careful consideration.

Interconnecting cables are not perfect conductors and offer resistance to current flow, the magnitude of resistance<sup>†</sup> depends on conductors resistivity, which changes with temperature, cross sectional area<sup>‡</sup> and length. If the voltage were to be measured at both ends of a length of wire it would be found they are different, this is known as volts drop. Volts drop changes with current flow and can be calculated using Ohm's law, it should be noted that volts drop occurs in both positive and negative conductors. The effects of volts drop can be reduced by increasing the conductors cross sectional area, this does not however eliminate the effects due to temperature variation. There are instances where large cross-section cables are not practical; for example most standard industrial connectors of the type used for sensors have a maximum conductor capacity of 0.75mm<sup>2</sup>, copper prices and ease of installation are other considerations.

This is important because the effects of volts drop can significantly alter the perceived accuracy of the sensor which is ratiometric i.e. the output signal is directly affected by the voltage across the sensor. Changes in temperature will also be seen as gain variation in the sensor output.

**Three wire mode** connections are common and are suitable in most cases with short or moderate cable runs. Applications that do not require a high degree of accuracy but have cable runs, say in excess of 10m, volts drop can reduced by introducing a terminal box close to the sensor and using a larger cross-section cable for a majority of the cable run. Sensors supplied with three core cable are calibrated with the cable fitted which largely eliminates errors due to conductor resistance at room temperature however, as mentioned above, small gain errors due to temperature fluctuations should be expected.

**Five wire mode** connections have significant benefits as losses in the positive and negative conductors are compensated for by the galvanic isolation amplifier which can 'sense' the voltage across the sensor and dynamically adjust the output voltage so that the voltage across the sensor is correct. The effects of cable resistance and associated temperature coefficients are eliminated allowing for smaller conductors than a three wire connection for the same cable run. The amplifier can compensate for up to 15Ω per conductor with a current flow of 15mA, which is more than adequate for 150m of 0.25 mm<sup>2</sup> cable, longer lengths will require larger conductors.

**For this reason Positek® recommends five wire connections for cable lengths exceeding 10 metres in 0.25 mm<sup>2</sup> cable to preserve the full accuracy of the sensor.**

See illustrations below for examples of connecting a sensor to the galvanic isolation amplifier.

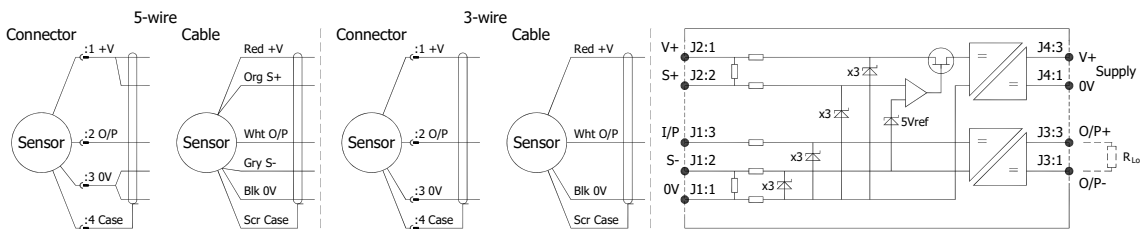

Cable Length (metres)	Up to 150	150 - 300	300 - 450	450 - 600	600 - 900	900 - 1000
Cross Section (mm <sup>2</sup> )	0.25	0.5	0.75	1.0	1.5	2.0

The table above shows recommended conductor sizes with respect to cable length for both three and five wire connections, based on copper conductors. Three wire connections will introduce a gain reduction of 5% and a ±1% temperature dependence of gain over the range -40°C to +80°C for the cable temperature. (i.e. about -150 ppm/°C for the maximum lengths shown and less pro rata for shorter lengths.)

It should be noted that the maximum cable length, as specified in the sensor certification, takes **precedence** and **must not** be exceeded.

Positek® sensors are supplied with three core 0.25 mm<sup>2</sup> cable as standard, however five core 0.25 mm<sup>2</sup> cable can be supplied on request. The galvanic isolation amplifier is available as;

G005-\*\*\* for 'G' and 'H' prefix sensors  
X005-\*\*\* for 'E', 'M' and 'X' prefix sensors

<sup>†</sup>  $R = \rho L/A$   $\rho$  is the resistivity of the conductor ( $\Omega m$ )  $L$  is the length of conductor (m)  $A$  is the conductor cross-sectional area (m<sup>2</sup>).

<sup>‡</sup> It is presumed that direct current flow is uniform across the cross-section of the wire, the galvanic isolation amplifier and sensor are a dc system.



# Generic Installation Information

## H SERIES SENSORS

INTRINSICALLY SAFE FOR HAZARDOUS GAS/VAPOUR & DUST ATMOSPHERES

CSA Qualified Intrinsically Safe Device Certificate number 13.2588225		Ex ia IIC T4 Ga Class I, Zone 0, AEx ia IIC T4 Ga Class I, Division 1, Groups A, B, C, D; T4 Ex ia IIIC T135°C Da Zone 20, AEx ia T135°C Da; Class II, Division 1, Groups E, F, G, T135°C; Class III Division 1; (Ta = -40°C to +80°C)	
Electronics Version	Output Description:	Supply Voltage: V <sub>s</sub> (tolerance)	Load resistance:
EX08	0.5 - 4.5V (ratiometric with supply)	+5V (4.5 - 5.5V) 10mA Nom.	5kΩ min

Connector Pin Layout:  
DIN 43650 C

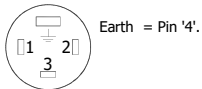

IEC 60947-5-2

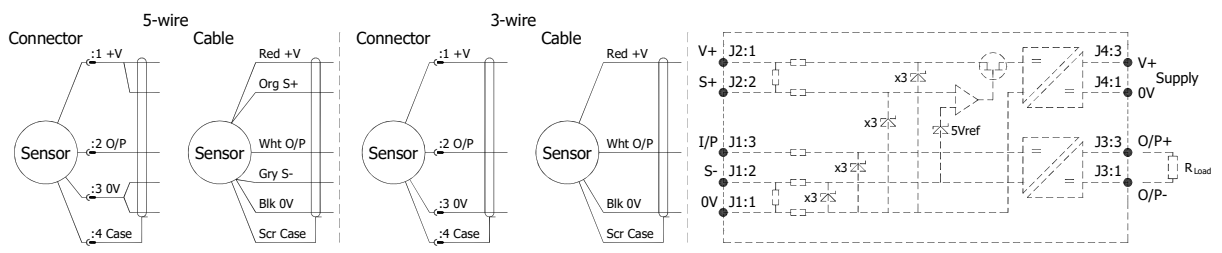

### Putting Into Service:

This sensor must only be installed, operated and maintained by competent and suitably trained personnel. The installation and maintenance must be carried out in accordance with all appropriate international, national and local standard codes of practice and site regulations for intrinsically safe apparatus. The use, installation, or maintenance of the sensor, in any other way than intended, may impair its operation or the protection it provides. The sensor must be used with a galvanic isolation barrier designed to supply the sensor with a nominal 5V and to transmit the sensor output to a safe area. The barrier parameters must not exceed:-

$$\begin{aligned}
 U_i &= 11.4V & I_i &= 0.20A & P_i &= 0.51W \\
 C_i &= 1.36\mu F^* & L_i &= 860\mu H^* & & \text{(with maximum length integral cable)} \\
 C_i &= 1.16\mu F & L_i &= 50\mu H & & \text{(without integral cable)}
 \end{aligned}$$

\*Figures for 1km cable where:  $C_i = 200\text{pF/m}$  &  $L_i = 810\text{nH/m}$

Cable characteristics must not exceed:-

$$\begin{aligned}
 \text{Capacitance:} &\leq 200 \text{ pF/m or max. total of: } 200 \text{ nF} \\
 \text{Inductance:} &\leq 810 \text{ nH/m or max. total of: } 810 \mu\text{H}
 \end{aligned}$$

Approval only applies to specified ambient temperature range and atmospheric conditions in the range: 0.80 to 1.10 Bar, oxygen  $\leq 21\%$ .

**Markings and safety parameter information for product marked EX06, see annex 1.**

### Environmental Conditions

Pollution degree: 2  
Installation category: I  
Humidity 80% to temperatures up to 31 °C decreasing linearly to 50% rH at 40 °C; /// max 80% rh, non condensing.  
The sensor has been assessed for indoor use only. Where used outdoors suitable environmental protection **must** be provided.

### Special Condition for Safe Use:

The apparatus does not meet the 500 V r.m.s dielectric strength test between circuit and frame, in accordance with clause 6.3.13 of IEC 60079-11:2011. This must be taken into consideration on installation.

When using a Sensor that has an integral cable in a dust application, the free end of the cable shall be appropriately terminated for the zone of use.

Under certain extreme circumstances, the non-metallic and isolated metal parts incorporated in the enclosure of this equipment may generate an ignition-capable level of electrostatic charge. Therefore the equipment shall not be installed in a location where the external conditions are conducive to the build-up of electrostatic charge on such surfaces. This is particularly important if the equipment is installed in a zone 0 location. In addition, the equipment shall only be cleaned with a damp cloth.

P.T.O.



For further information please contact:

[www.positek.com](http://www.positek.com) [sales@positek.com](mailto:sales@positek.com)

Tel: +44(0)1242 820027 fax: +44(0)1242 820615

Positek, Andoversford Industrial Estate, Cheltenham GL54 4LB. U.K.

H000-19d

1 of 2



# Generic Installation Information

## H SERIES SENSORS

INTRINSICALLY SAFE FOR HAZARDOUS GAS/VAPOUR & DUST  
ATMOSPHERES

### Use:

The sensor is designed to measure Linear or rotary displacement and provide a proportional analogue output signal.

### Assembly and Dismantling:

The unit is not to be serviced or dismantled and re-assembled by the user.

WARNING: Substitution of components may impair intrinsic safety

AVERTISSEMENT: La substitution de composants peut altérer la sécurité intrinsèque.

### Maintenance:

Accumulated dust layer must not exceed a depth of 200mm.

### Annex 1 - Markings and Entity Parameters for product with EX06 electronics system.

Class I, Zone 0

Ex ia IIC T4 (Ta= -40 to 80°C)

AEx ia IIC T4 (Ta= -40 to 80°C)

AEx iaD IIIC T93°C (Ta= -40 to 80°C)

**Ui = 11.4V**      **Ii = 0.20A**      **Pi = 0.51W**

**Ci = 1.36µF\***      **Li = 710µH\***      (with maximum length integral cable)

**Ci = 1.16µF**      **Li = 50µH**      (without integral cable)

\*Figures for 1km cable where: Ci = 200pF/m & Li = 660nH/m

Cable characteristics must not exceed:-

Capacitance: ≤ 200 pF/m or max. total of: 200 nF

Inductance: ≤ 660 nH/m or max. total of: 660 µH





# Installation Information

## H101 STAND-ALONE LINEAR POSITION SENSOR INTRINSICALLY SAFE FOR HAZARDOUS DUST ATMOSPHERES

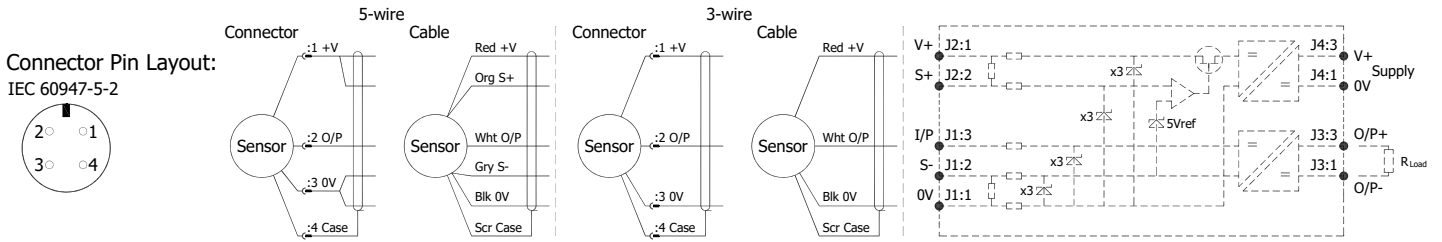

N.b. sensors supplied with cable, the free end must be appropriately terminated.

**Warning** - The M12 IEC connector may be rotated for purposes of convenient orientation of the connector and cable, however rotating the connector more than one complete revolution is not recommended. **Repeated rotation of the connector will damage the internal wiring!**

**Mechanical Mounting:** Depending on options; Body can be mounted by rod eye or by clamping the sensor body - body clamps are available, if not already ordered. Target by M5x0.8 female thread, rod eye or magnetic tip. It is assumed that the sensor and target mounting points share a common earth.

**Output Characteristic:** Target is extended 9 mm from end of body at start of normal travel. The output increases as the target extends from the sensor body, the calibrated stroke is between 5 mm and 800 mm.

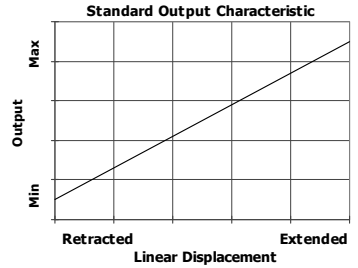

**Incorrect Connection Protection levels: Not protected** – the sensor is **not** protected against either reverse polarity or over-voltage. The risk of damage should be minimal where the supply current is limited to less than 50mA.